



© Copyright Ford-Werke GmbH 2021

Printed Copies are uncontrolled

Expert Fitment Required
Montage durch Fachwerkstatt erforderlich
Montaje sólo por el concesionaria
Montage par spécialiste nécessaire
E' necessario montaggio in officina specializzata
Especialista em montagem requerido
Montage door vakman nodig
Montage ved professionelt værksted påkævet
Nødvendig med montering fra fagvejværksted
Værkstedsmontage erfordras
Asennus tarpeen merkkikorjaamossa
Montáž ve specializované dílně nutná
A szereléshez szakműhely kell
Konieczny montaż przez warsztat specjalistyczny
Na τοποθέτησι από συνεργείο
Монтаж должен проводиться только в
специализированных мастерских
Montaj tamirhane tarafından yapılmalıdır
Montajul trebuie efectuat de un atelier
de specialitate

Subject to alteration without notice
Technische Änderungen vorbehalten
Reservadas modificaciones técnicas
Sous réserve de modifications techniques
Con riserva di apportare modifiche tecniche
Reservamo-nos o direito a alterações técnicas
Technische wijzigingen voorbehouden
Med forbehold for tekniske ændringer
Tekniske forendringer forbeholdes
Med reservation för tekniska ändringar
Tekniset muutokset pidätetään
Technické zmeny vyhrazeny
A változtatások technika jogát fenntartjuk
Zmiany techniczne zastrzeżone
Επιφύλασσόμεθα για αλλαγές
Производитель оставляет за собой право
вносить в конструкцию технические изменения
Teknik değışiklik hakkı mahfuzdur
Ne rezervăm dreptul la modificări tehnice

EN	INSTALLATION INSTRUCTION OE1 ARMREST (WITHOUT USB)
D	EINBAUANLEITUNG OE1 ARMLEHNE (OHNE USB)
E	INSTRUCCIONES DE MONTAJE OE1 REPOSABRAZOS (SIN USB)
F	NOTICE DE MONTAGE OE1 ACCOUDOIR (SANS USB)
I	ISTRUZIONI DI MONTAGGIO OE1 BRACCIOLO (SENZA USB)
P	INSTRUÇÕES DE MONTAGEM OE1 APOIO DE BRAÇO (SEM USB)
NL	INBOUW-INSTRUCTIE OE1 ARMSTEUN (ZONDER USB)
DK	MONTERINGSVEJLEDNING OE1 ARMLÆN (UDEN USB)
N	MONTERINGSVEILEDNING OE1 ARMLENE (UTEN USB)
S	MONTERINGSANVISNING OE1 ARMSTÖD (UTAN USB)
SF	ASENNUSOHJE KÄSINOJA, OE1-MUOTOILU (EI USB-LIITÄNTÄÄ)
CZ	NÁVOD K MONTÁŽI OE1 OPĚRKA PRO RUCI (BEZ USB)
H	BESZERELÉSI UTASÍTÁSA OE1 KARTÁMASZ (USB NÉLKÜL)
PL	INSTRUKCJA MONTAŻU PODŁOKIETNIK OE1 (BEZ USB)
GR	ΟΔΗΓΙΕΣ ΤΟΠΟΘΕΤΗΣΗΣ ΥΠΟΒΡΑΧΙΟΝΙΟ OE1 (ΧΩΡΙΣ USB)
TR	MONTAJ TALİMATLARI OE1 KOLÇAK (USB'SİZ)
RUS	ИНСТРУКЦИЯ ПО МОНТАЖУ OE1 ПОДЛОКОТНИК (БЕЗ USB)
RO	INSTRUCȚIUNI DE MONTAJ OE1 COTIERĂ (FĂRĂ USB)

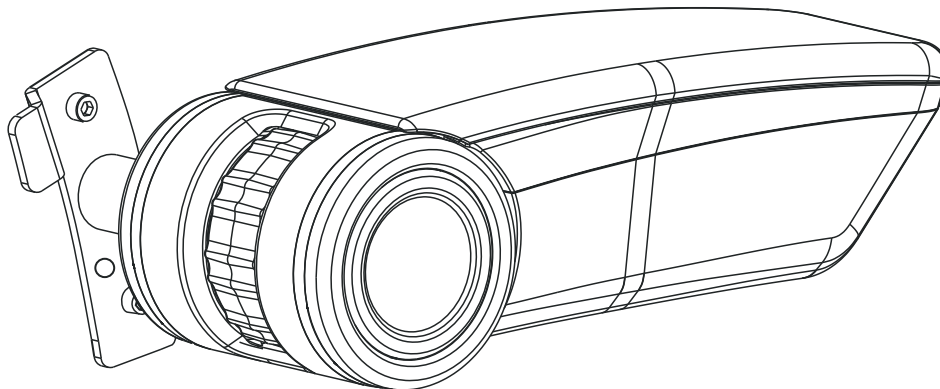

A66FLA-A045C74-JA

15/06/2021

1/7



- (EN) Caution Symbol
- (D) Symbol "Vorsicht"
- (E) Símbolo de precaución
- (F) Symbole Attention
- (I) Simbolo di attenzione
- (P) Símbolo de Cuidado
- (NL) Symbool "waarschuwing"
- (DK) Symbol - Giv agt
- (N) Varselssymbol
- (S) Varningssymbol
- (SF) Varoitussymboli
- (CZ) Symbol výstrahy
- (H) Vigyázat szimbólum
- (PL) Ostrożnie
- (GR) Σύμβολο «Προσοχή»
- (TR) Dikkat Sembolü
- (RUS) Знак «Внимание!»
- (RO) Simbol de atenționare

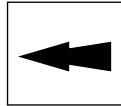

- (EN) Item Arrow
- (D) Pfeil "Komponente"
- (E) Flecha de artículo
- (F) Flèche d'élément
- (I) Freccia indicante oggetto
- (P) Seta indicadora de item
- (NL) Pijl "onderwerp"
- (DK) Pil - Punkt
- (N) Delpil
- (S) Komponentpil
- (SF) Kohteen nuoli
- (CZ) Šipka označující položku
- (H) Tételt jelző nyíl
- (PL) Strzałka wskazująca element
- (GR) Βέλος που υποδεικνύει ένα στείλ
- (TR) Parça Oku
- (RUS) Стрелка на пункт
- (RO) Săgeată ce indică articolul

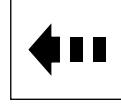

- (EN) Motion Arrow
- (D) Pfeil Bewegung
- (E) Flecha de movimiento
- (F) Flèche de déplacement
- (I) Freccia indicante movimento
- (P) Seta de movimento
- (NL) Pijl "beweging"
- (DK) Retningspil
- (N) Bevegelsespil
- (S) Rörelsepil
- (SF) Liikkeen nuoli
- (CZ) Šipka označující pohyb
- (H) Mozgás irányát jelző nyíl
- (PL) Strzałka wskazująca kierunek ruchu
- (GR) Βέλος που υποδεικνύει κίνηση
- (TR) Hareket oku
- (RUS) Стрелка направления движения
- (RO) Săgeată ce indică mișcarea

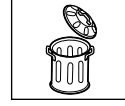

- (EN) Throw away
- (D) Entsorgen
- (E) Tratamiento de residuos
- (F) Rebuter
- (I) Smaltire
- (P) Eliminar
- (NL) Weggooien
- (DK) Affald
- (N) Avskaffe
- (S) Ta hand om avfallet
- (SF) Hävittää
- (CZ) Vyhodit
- (H) Távolítsa el
- (PL) Usunąć jako odpad
- (GR) Απόσυρση
- (TR) Atık giderme
- (RUS) Удалить
- (RO) Eliminare

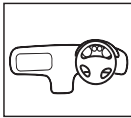

- (EN) Right Hand Drive Vehicle
- (D) Rechtss gelenktes Fahrzeug
- (E) Volante a la derecha
- (F) Véhicule direction à droite
- (I) Veicolo con guida a destra
- (P) Condutor à direita
- (NL) Stuurwiel rechts
- (DK) Højrestyret køretøj
- (N) Høyre ratt kjøretøy
- (S) Högerstyrd fordon
- (SF) Oikealta ohjattava ajoneuvo
- (CZ) Vozidlo s řízením vpravo
- (H) Jobbkormányos gépjármű
- (PL) Pojazd z kierownicą z prawej strony
- (GR) Δεξιόστροφο όχημα
- (TR) Sağdan direksiyonlu araç
- (RUS) Автомобиль с правосторонним управлением
- (RO) Vehicul cu volan în partea dreaptă

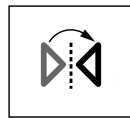

- (EN) Mirror image
- (D) Spiegelbild
- (E) Imagen simétrica
- (F) Image de miroir
- (I) Immagine dello specchio
- (P) Imagem do espelho
- (NL) Mirror beed
- (DK) Spejlbilde
- (N) Speilbilde
- (S) Spegelbild
- (SF) Pellikuva
- (CZ) Věrný obraz
- (H) Tükürcép
- (PL) Odbicie lustrzane
- (GR) εικόνακαθρεφτών
- (TR) Aynadaki görüntü
- (RUS) зеркальное отражение
- (RO) Imagine în oglindă

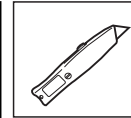
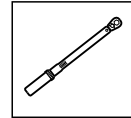

- (EN) Tools Required
- (D) Benötigte Werkzeuge
- (E) Herramientas requeridas
- (F) Outils requis
- (I) Strumenti necessari
- (P) Ferramentas necessárias
- (NL) Benodigd gereedschap
- (DK) Nødvendige værktøjer
- (N) Nødvendig verktøy
- (S) Nödvändiga verktyg
- (SF) Tarvittavat työkalut
- (CZ) Potřebné nástroje
- (H) Szükséges szerszámok
- (PL) Potrzebne narzędzia
- (GR) Εργαλεία που απαιτούνται
- (TR) Gerekl Araçlar
- (RUS) Необходимые инструменты
- (RO) Unele necesare

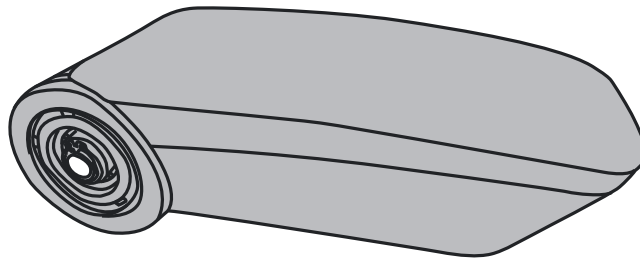
A

1x

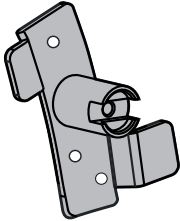
B

1x

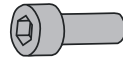
C

2x

D

2x

E

1x

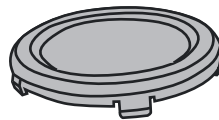
F

1x

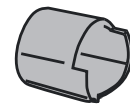
G

1x

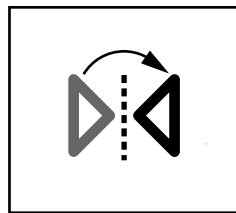
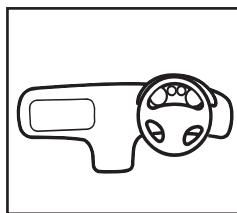

A66FLA-A045C74-JA

© Copyright Ford-Werke GmbH 2021

3/7

PUMA 2019 ➡



1 - 5, 9 - 14

FOCUS 2017 ➡



1 - 5, 9 - 14

ECOSPORT 2017 ➡



1 - 5, 9 - 14

KA+ ACTIVE 2017 ➡



6 - 14

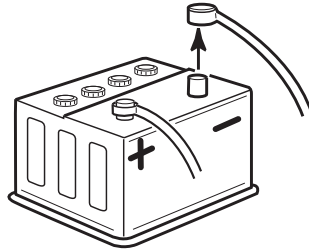

1

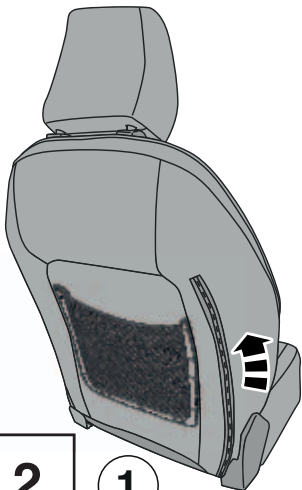

2

1

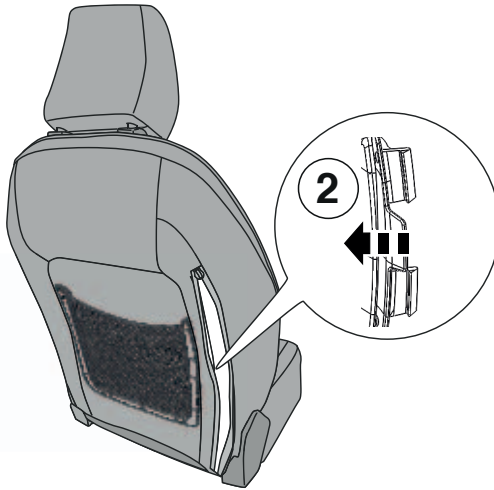

2

3

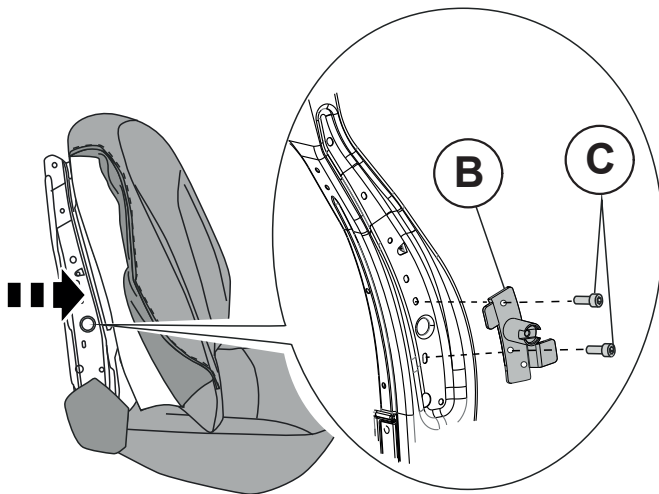
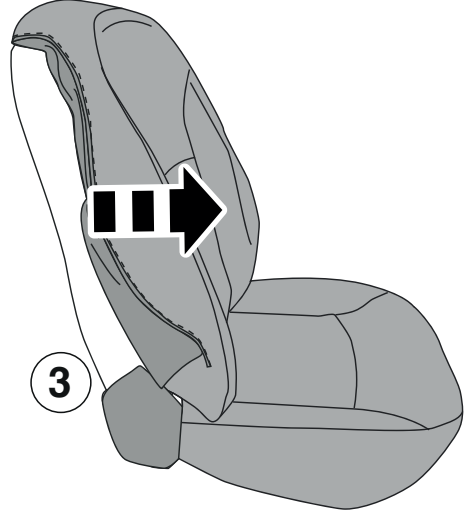

3

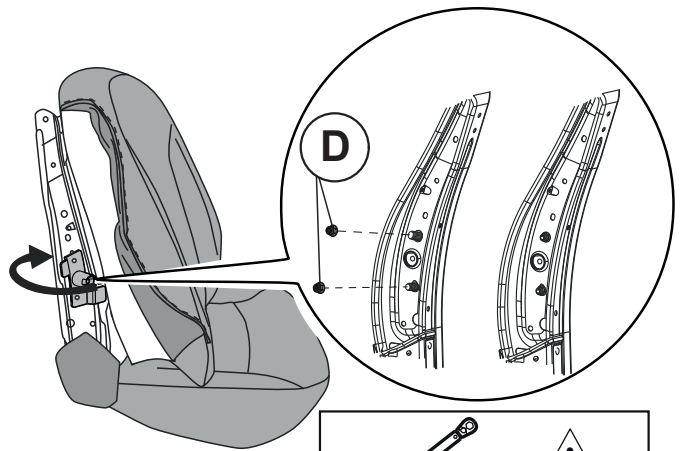

12Nm

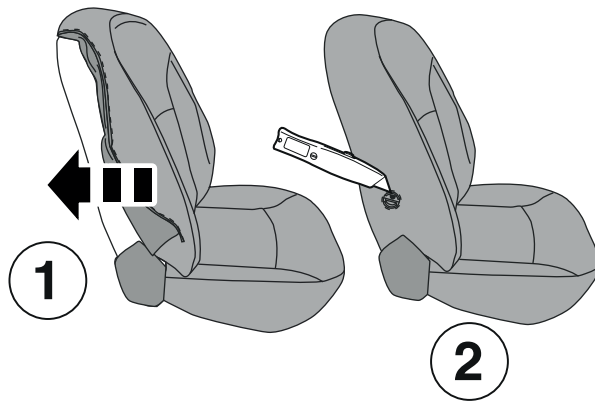
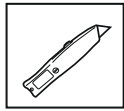

4

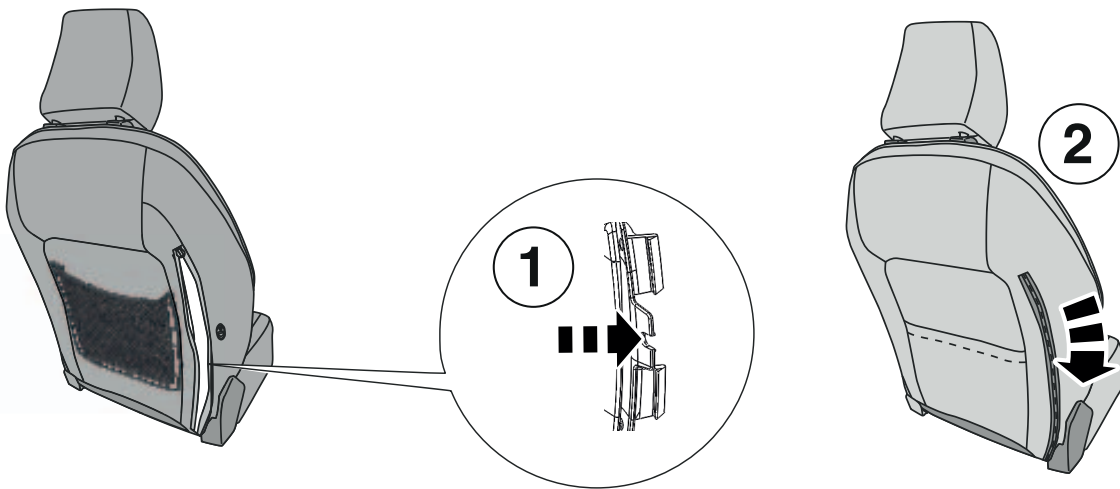

5

KA+ ACTIVE 2017

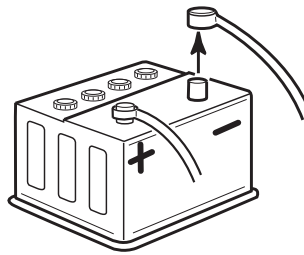

6

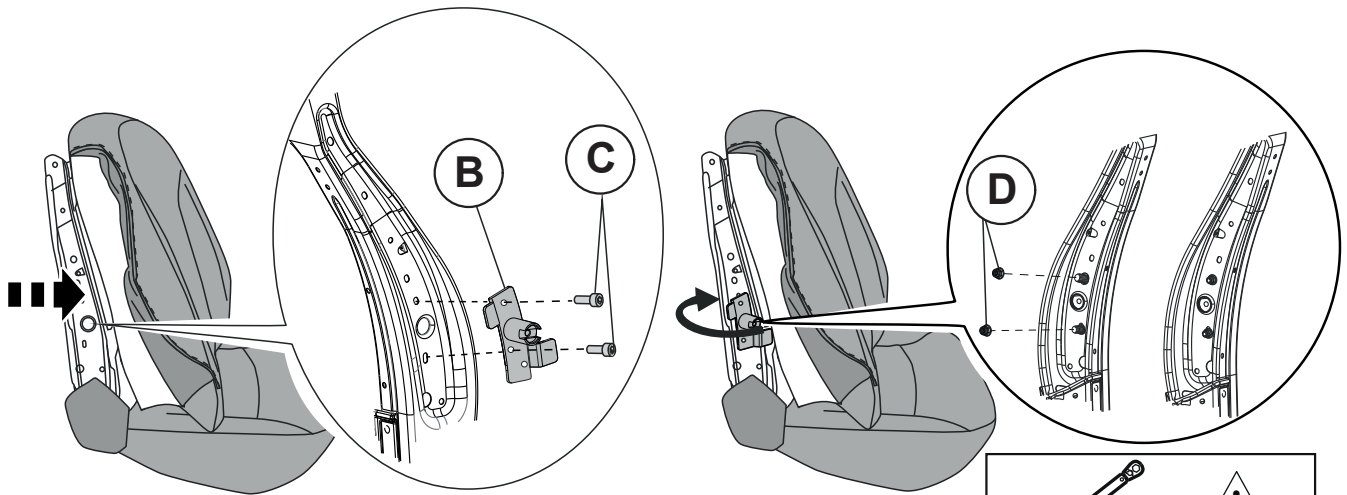

7

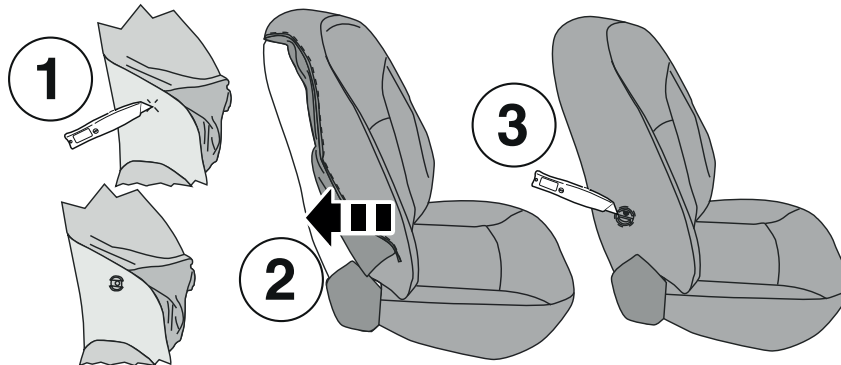
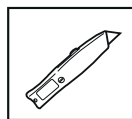
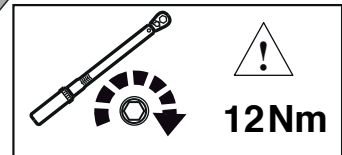

8

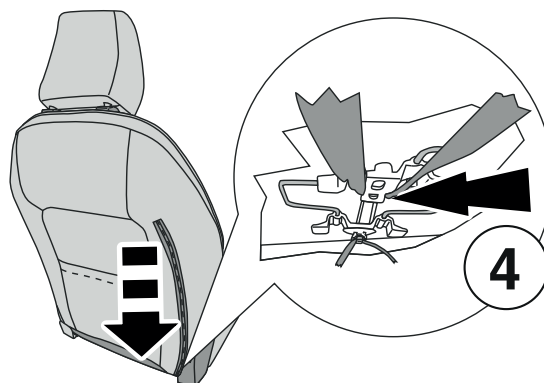

9

10

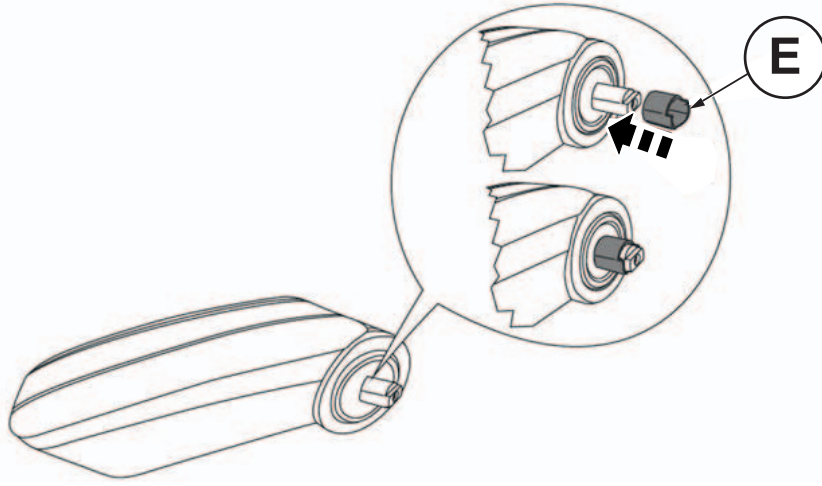

11

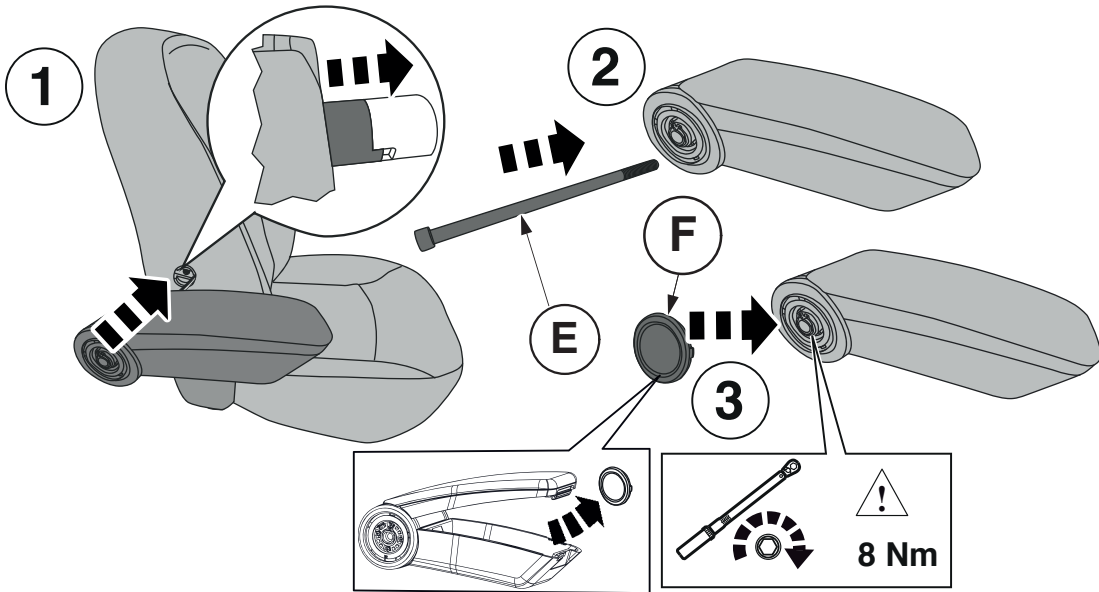

12

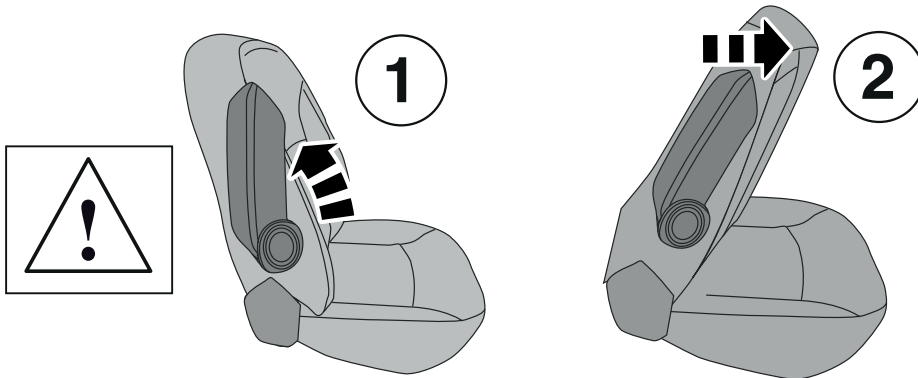

13

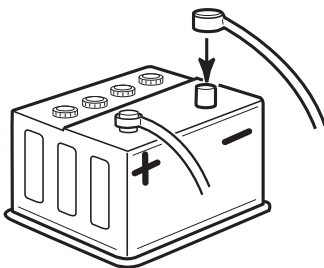

14

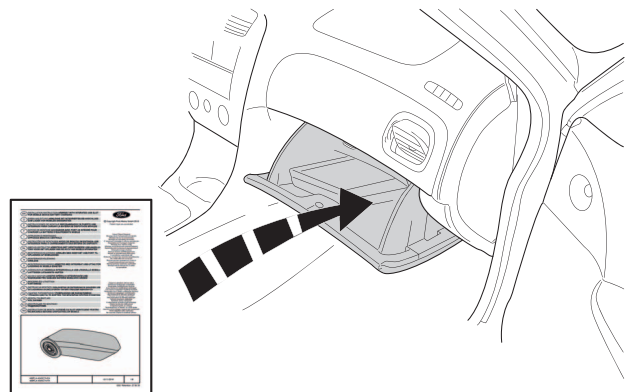

A66FLA-A045C74-JA

© Copyright Ford-Werke GmbH 2021

7/7